



**b** bech  
packaging

---

## COMPANY **PRESENTATION**



---

[www.bechpackaging.com](http://www.bechpackaging.com)

# ABOUT US

---

**WE SPECIALIZE IN PRODUCTION OF PACKAGING FOR COSMETICS, PHARMACEUTICAL FOOD AND CHEMICAL INDUSTRIES. WIDE BASIC RANGE, AS WELL AS STRONG DESIGN DEPARTMENT AND TOOL SHOP ALLOW YOU TO CREATE UNIQUE PRODUCT.**

THE EQUIPMENT AND PRODUCTION MATERIALS USED IN BECH PACKAGING MEET THE NECESSARY STANDARDS AND OUR PRODUCTS ARE ALWAYS OF THE HIGHEST QUALITY.

**WE CREATE DURABLE, INTERESTING AND CUSTOMIZED PACKAGING, THUS CREATING MARKET TRENDS.**

---

[www.bechpackaging.com](http://www.bechpackaging.com)

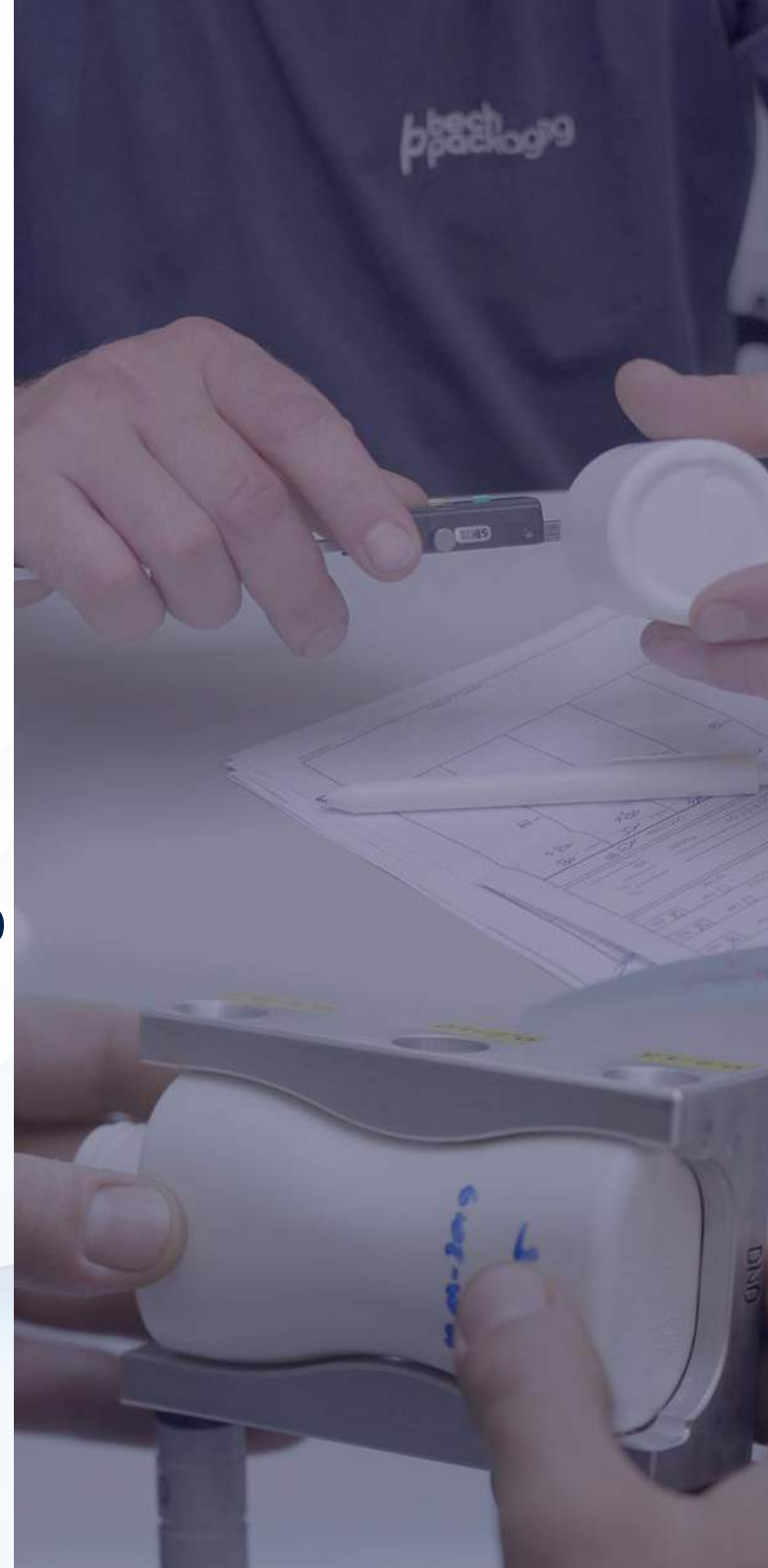

# HISTORY

## BECH PACKAGING

---



**THE HISTORY OF BECH PACKAGING BEGINS IN THE MID-1950s -  
UNDER THE NAME SCANBECH.**

THE NAME HAS CHANGED, BUT TO THIS DAY BECH PACKAGING  
REMAINS A FAMILY OWNED COMPANY.

---

[www.bechpackaging.com](http://www.bechpackaging.com)

# INDUSTRIES



## BECH PACKAGING

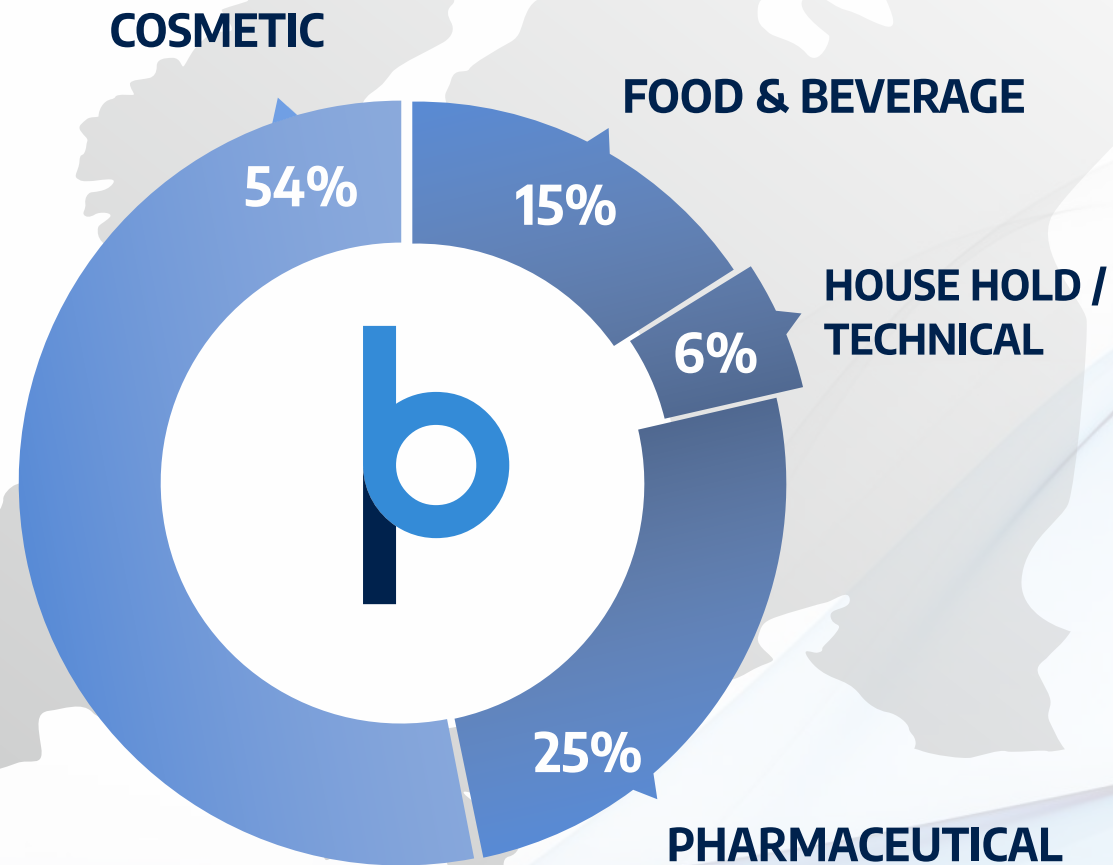



# MARKET SHARE

---

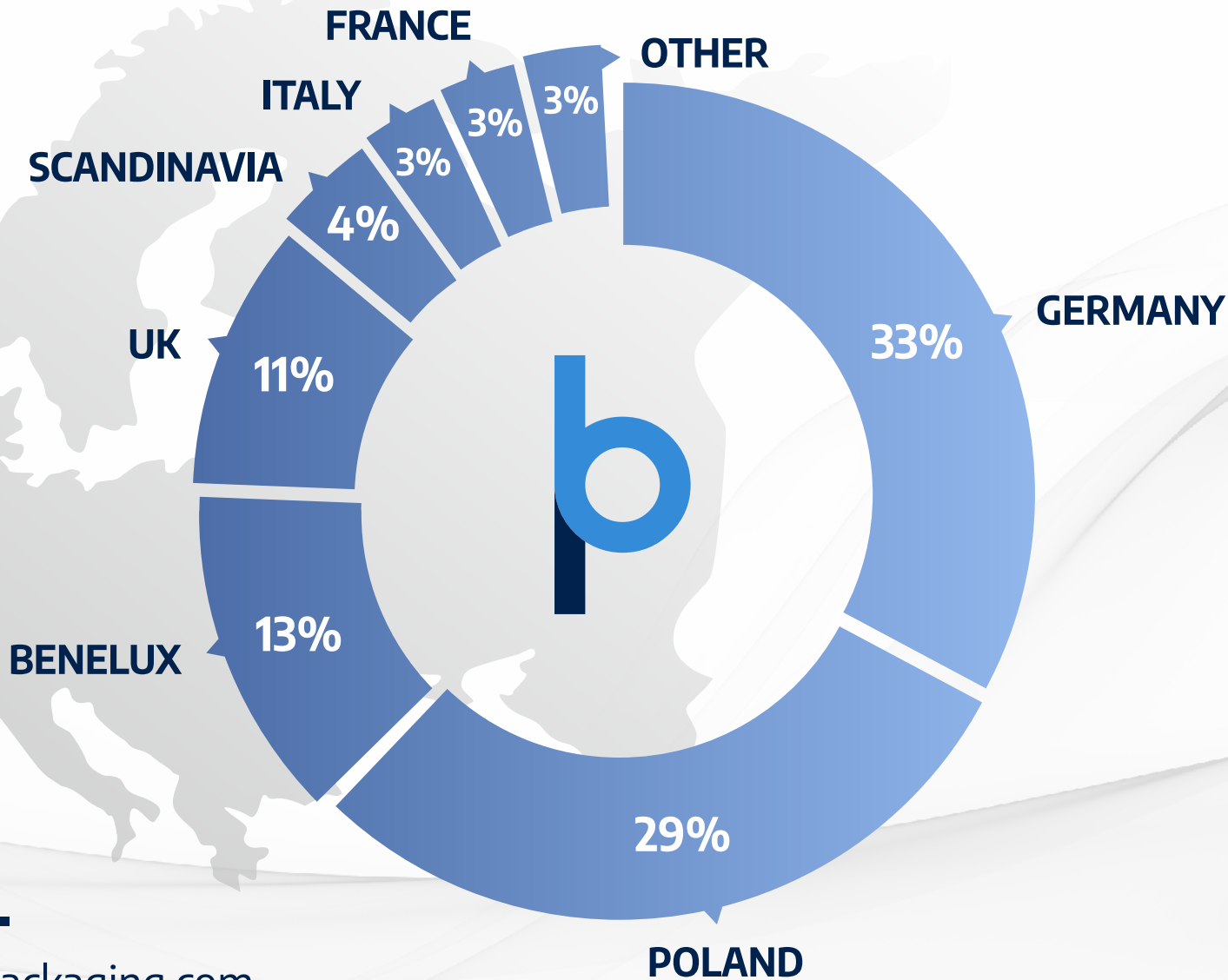

# ORGANIC DEVELOPMENT

---

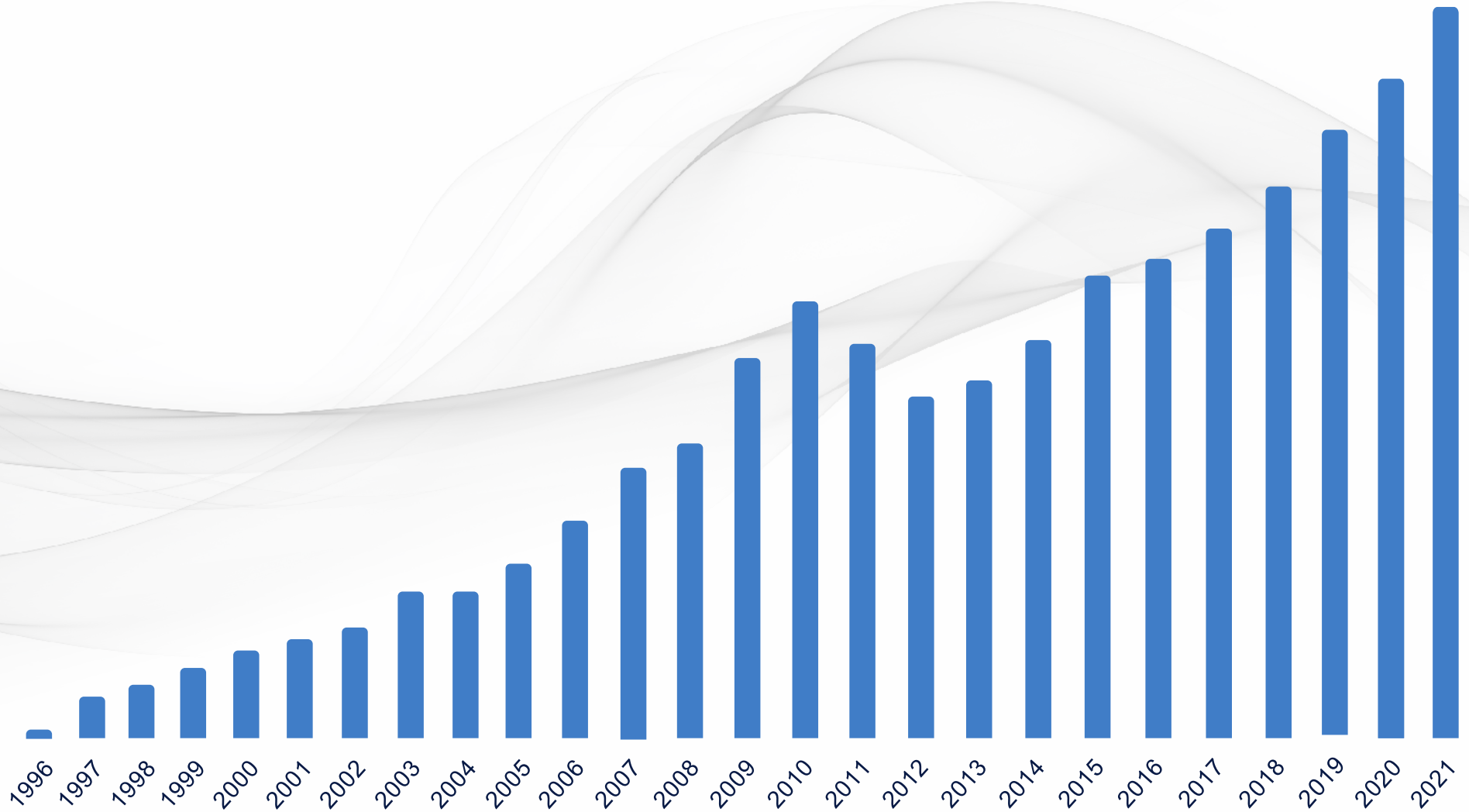

# PRODUCTS - STANDARDS



- **WIDE STANDARD** ASSORTMENT ACCORDING TO ACTUAL MARKET TRENDS
- **OVER 700** STANDARD PRODUCTS



# PRODUCTS - STANDARDS

---



- **BOTTLES AND CLOSURES** FOR COSMETICS, FOOD AND PHARMA
- **VARIOUS TECHNOLOGIES:** BM, IM, ISBM
- **ALL RECYCLABLE MATERIALS:** PE, PP, PET
- **PCR:** HDPE, LDPE, PET
- **BIO-BASED MATERIALS:** GREEN PE



# PRODUCTS - R&D

---



- WE FACE THE MOST SOPHISTICATED **DESIGN CHALLENGES**
- **OVER 40 CUSTOM LAUNCHES EVERY YEAR**

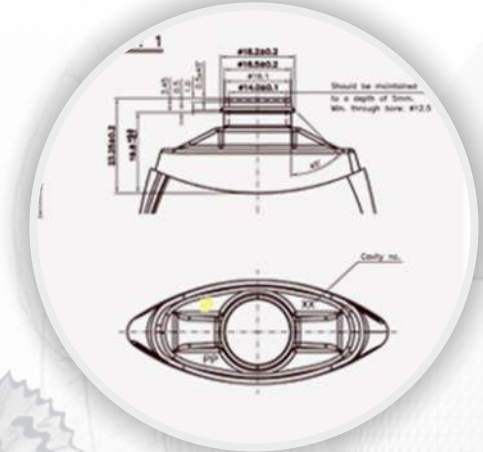



# R&D

---

- **DESIGN AND DEVELOPMENT PATENT REGISTRATIONS IN EU AND USA**
- **ADVANCED PROCESS SYMULATION**
- **EXPERIENCE**
- **PROFESSIONAL LAUNCH SUPPORT**

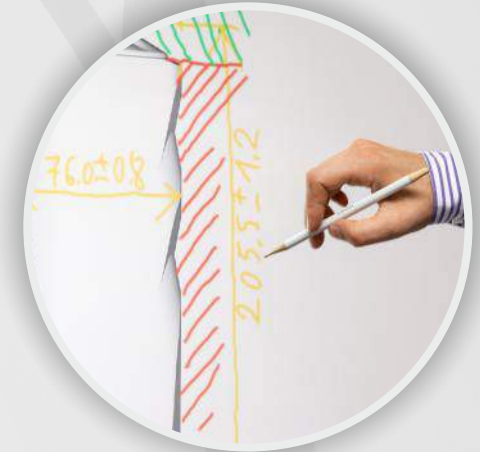
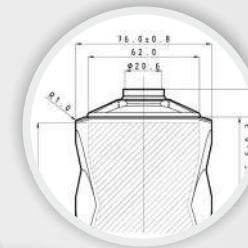



# PRODUCTION

---



- **25 YEARS OF EXPERIENCE, 50 MODERN PRODUCTION LINES AND ADVANCED PERIPHERAL EQUIPMENT SECURE THE HIGHEST QUALITY OF PRODUCTS**





# QUALITY

---

- EXTERNAL COMPLAINTS < **0,03%**
- ISO **9001**
- ISO **14001**
- ISO **45001**
- **LABORATORY**
- **EDUCATION**
- INVESTMENTS / **DEVELOPMENT**





# SERVICE

---



- **FINDING THE RIGHT** PACKAGING IS JUST THE BEGINNING OF A JOURNEY. MANY ADDITIONAL PROCESSES WILL APPEAR DURING PRODUCT LIFETIME.
- **BECH PACKAGING** ENSURES THE HIGHEST QUALITY OF SERVICES. HIGHLY QUALIFIED, EXPERIENCED STAFF WILL GUARANTEE THAT YOU CAN DEVOTE YOUR PRECIOUS TIME TO OTHER THINGS.



# ENVIRONMENT



## RECYCLABLE MATERIALS IN USE ONLY

- PCR
- PE
- PP
- PET
- GREEN PE



**SAVING FOSSIL RESOURCES BY USING BIOMASS PROVIDES A UNIQUE POTENTIAL OF CARBON FOOTPRINT REDUCTION. CAN POSSESS PROPERTIES THAT ARE IDENTICAL TO THEIR CONVENTIONAL VERSIONS. CAN BE RECYCLED IN EXISTING RECYCLING STREAMS.**

[www.bechpackaging.com](http://www.bechpackaging.com)

ECOLOGY STARTS AT HOME.



GRAPHICS BASED ON THE STUDY BY THE EUROPEAN COMMISSION.



# ENVIRONMENT

---

- **CONSTANT WEIGHT REDUCTION**
- **PROCESS WASTE RECOVERY**  
(OVER 99%)
- **RECUPERATION** OF THERMAL ENERGY  
OF MACHINES AND DEVICES
- **REDUCTION OF ELECTRICITY CONSUMPTION**  
THROUGH THE USE OF MODERN PRODUCTION MACHINES



# ENVIRONMENT

---

- **THE USE OF ENVIRONMENTALLY SAFE CHEMICALS IN THE PLANT**
- **PREPARATION FOR THE CLOSED-CIRCUIT ECONOMY**
- **RECYCLABLE MATERIALS IN USE ONLY**





# ENVIRONMENT

---

WE BELIEVE THAT PLASTIC  
IS THE MATERIAL OF THE FUTURE.  
**WE USE IT RESPONSIBLY!**

**DYNAMIC DEVELOPMENT OF MODERN CIVILIZATION AND AN INCREASING LEVEL OF CONSUMPTION** LEAD TO THE PROBLEM OF HUGE AMOUNTS OF WASTE. TO EFFICIENTLY TACKLE THIS PROBLEM, WE MUST RAISE PEOPLE'S AWARENESS AND CHANGE OUR HABITS.

**EDUCATIONAL INITIATIVES IN ECOLOGY CONSTITUTE**  
AN ESSENTIAL ELEMENT OF THE STRATEGY,  
AS DO ALL KINDS OF ECONOMIC MOTIVATION  
ENCOURAGING PROPER,  
**ENVIRONMENTALLY-FRIENDLY BEHAVIOR.**



# WHY BECH PACKAGING?

---



## SERVICE

- **HIGH LEVEL** OF CUSTOMERS / BUSINESS HANDLING
- **LARGE PORTFOLIO** OF STANDARD ASSORTMENT
- **R&D.** NEW PRODUCTS DEVELOPMENT. HIGH LEVEL OF SERVICE
- **QUICK REACTION** TIME. EXPERIENCED SALES STAFF



## QUALITY:

- **GOOD QUALITY** LEVEL
- **GREAT EXPERIENCE**
- QUICK AND **PROFFESIONAL REACTION**
- **RELIABLE AND PROVED** SUPPLIERS



# WHY BECH PACKAGING?

---



## ECONOMY

- **WELL BALANCED** PRICE LEVEL
- **EXCELLENT** GEOGRAPHICAL LOCATION

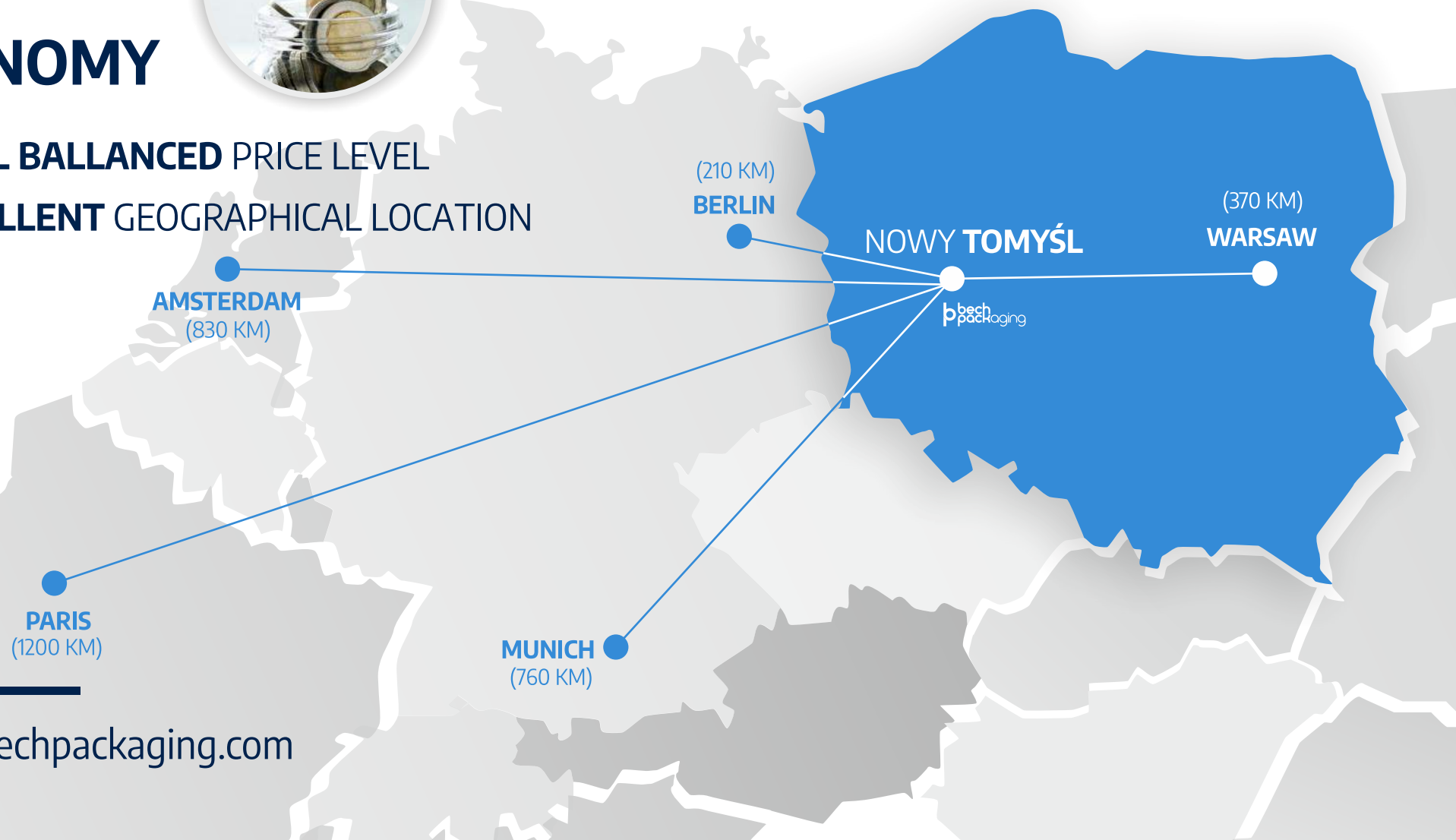





**b** bech  
packaging

[www.bechpackaging.com](http://www.bechpackaging.com)